

STANDARD CONSTRUCTION

OPTIONAL CONSTRUCTION

STATIONARY DRAINABLE GALVANIZED STEEL LOUVER

DWF-02/SERIES

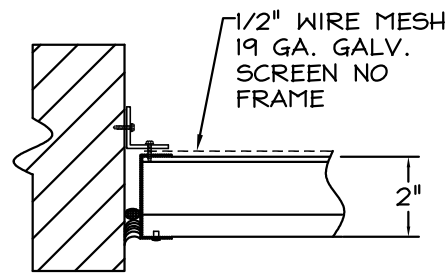

(EXTERIOR)

BOX FRAME

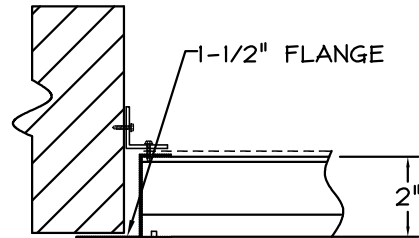

(EXTERIOR)

FLANGE FRAME

2-1/8" TYP. MULLION FRONT & BACK

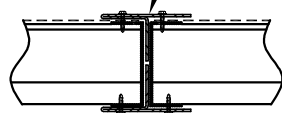

(EXTERIOR)

VERTICAL VISIBLE MULLION

1-1/4" x 1-1/4" x 12 GA VERT. SUPPORT W/ BLADE BRACES

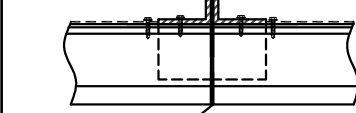

1/8" EXP. JOINT

(EXTERIOR)

VERTICAL INVISIBLE MULLION

2-1/8" TYP. MULLION FRONT & BACK

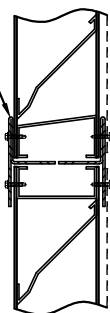

(EXTERIOR)

HORIZONTAL VISIBLE MULLION

JAMB SPLICE PLATE

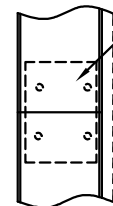

(EXTERIOR)

HORIZONTAL INVISIBLE MULLION

1-1/4" x 1-1/4" x 12 GA VERT. SUPPORT W/ BLADE BRACES

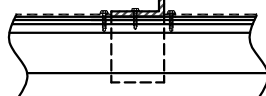

(EXTERIOR)

CONTINUOUS BLADE

1-7/8" x 1" x .081" SEMI-INVISIBLE MULLION

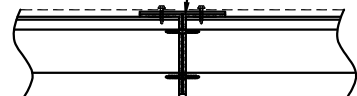

(EXTERIOR)

SEMI-INVISIBLE MULLION

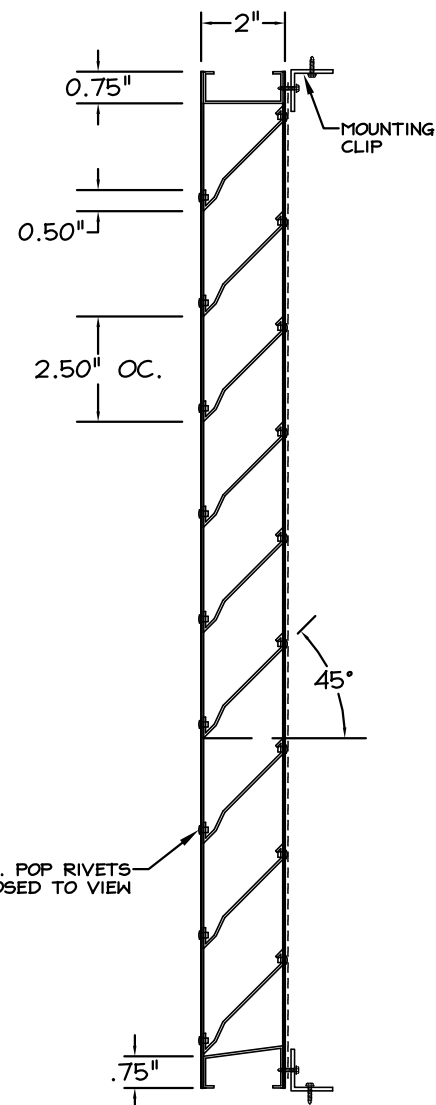

VERTICAL SECTION

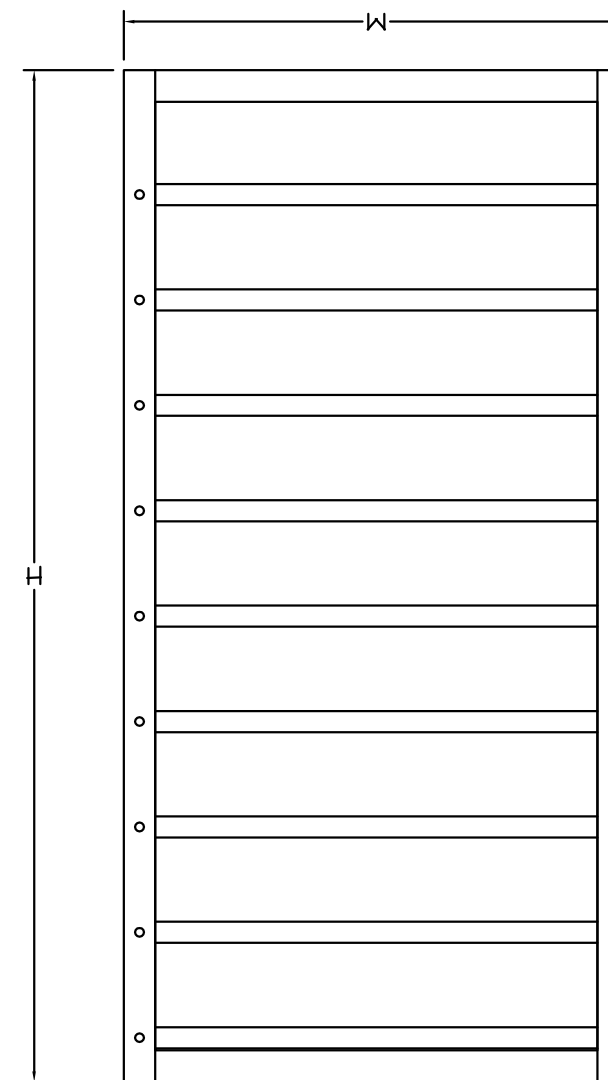

FRONT ELEVATION

REV.	DESCRIPTION	DATE	BY

STANDARD CONSTRUCTION:

FRAME: 20 GAUGE GALVANIZED STEEL
 BLADES: 20 GAUGE GALVANIZED STEEL
 FASTENERS: STL. POP RIVETS EXPOSED TO VIEW
 SCREEN: 1/2" WIRE MESH 19 GAUGE GALVANIZED SCREEN NO FRAME
 FINISH: MILL

NOTES:

1. ALL LOUVERS TO BE FABRICATED 3/8" UNDER LISTED OPENING SIZES UNLESS SPECIFIED "ACTUAL"
2. ALL OPENING SIZES TO BE FIELD VERIFIED AND GUARANTEED BY OTHERS PRIOR TO FABRICATION.
3. OTHER SURROUNDING FINISHES ARE FOR REFERENCES ONLY AND TO BE SUPPLIED BY OTHERS.

LOUVER SCHEDULE

TAG	QTY	SIZE (WXH)	NOTES



DEPENDABLE PRODUCTS SINCE 1955

1855 SOUTH 54TH AVENUE, CICERO, IL. 60650

ARCH/ENGR:

CUSTOMER:

PROJECT:

TITLE:

DWF-02/SERIES

DATE:

DRAWN:

SCALE: 1:1

CHKD:

DRWG #: